

# RUG3 RTU

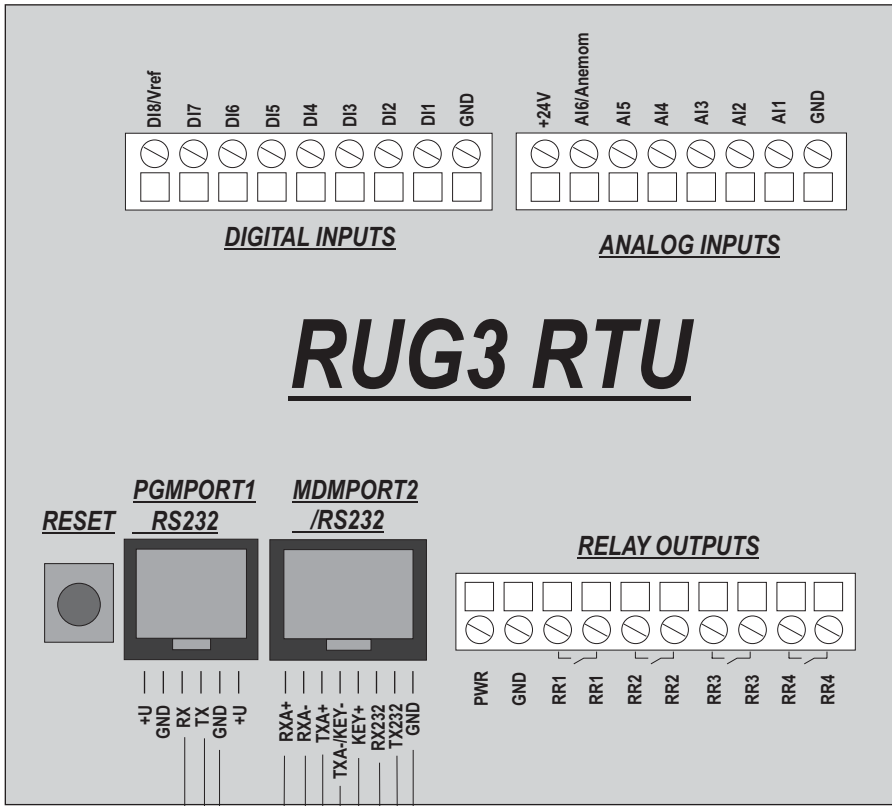

**MDMPORT2 /RS232**

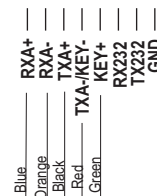

**MDMPORT2 /RS232**

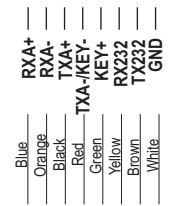

**CBLRJ45 PIGTAIL, 2 Ft.**

**CBLR3AUDIO, 2 Ft.**

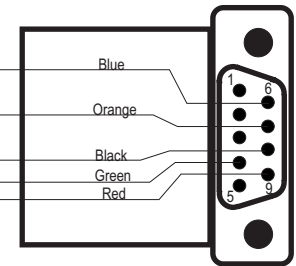

**MDMPORT2 /RS232**

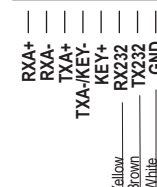

**CBLR3M232, 2 Ft.**

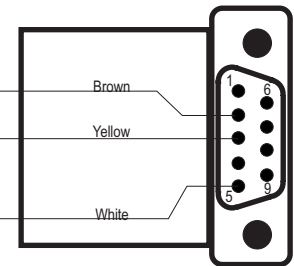

**CBLR3MDMFULL, 2 Ft.**

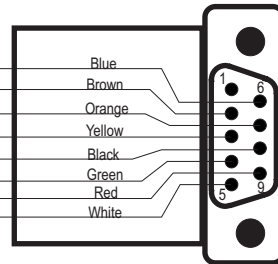

All modular cables must be built this way

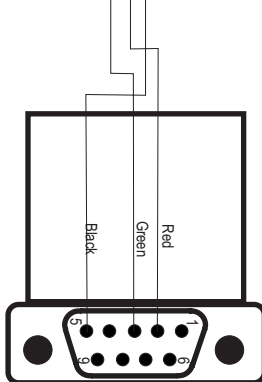

**CBLR3PGM, 14 Ft.**

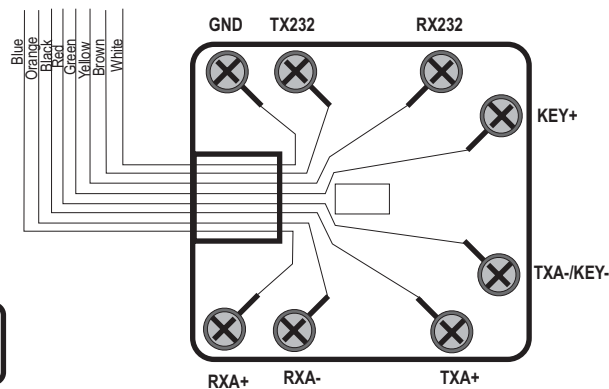

**CBLR3SCREWJACK, 2 Ft.**

## RUG3 STANDARD CABLES

File: R3CABLES.CDR

By: DAB

Date: 03/03/03

Rev: A

**RUGID COMPUTER**

6305 Elizan DR NW

Olympia, WA 98502

E-mail: donb@rugidcomputer.com

(360) 866-4492 FAX (360) 866-4492